

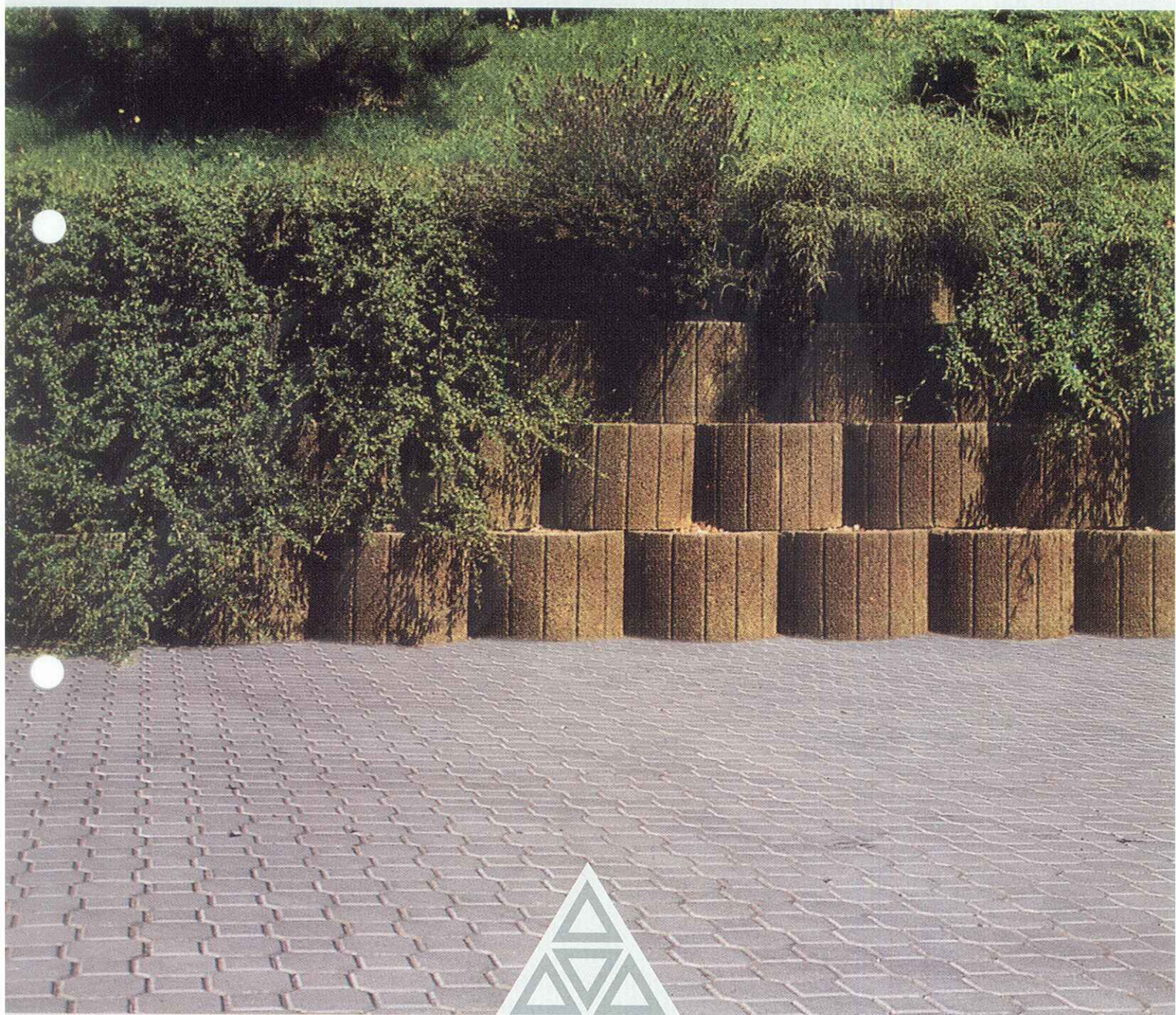

FARFALLINO

La soluzione pratica e piacevole in opere di consolidamento



VENIR
ARTICOLI IN BETON

FARFALLINO

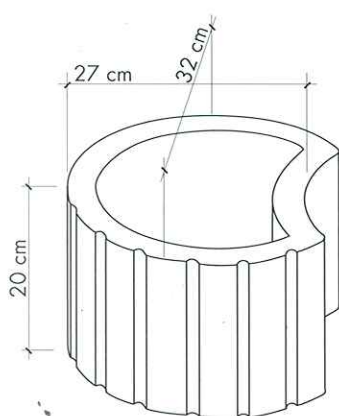

Elemento in calcestruzzo adatto alla realizzazione di muri di contenimento, rivestimento di scarpate, alla formazione di aiuole oppure semplici

cemente come fioriera, utilizzando la apposita lastrina per la formazione del fondo. Farfallino è disponibile nei colori grigio e bruno.

peso ca. kg/m ²	pezzi/ m ²	pezzi/ paletta	peso ca. kg/paletta	peso ca. kg/lastrina
15,4	18,5	60	950	2,0



Applicazioni

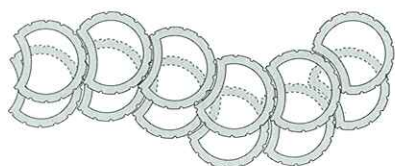

Scarpata a curva libera

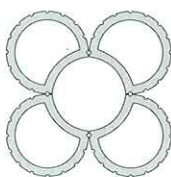

Aiuola

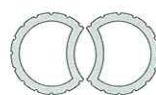

Fioriera

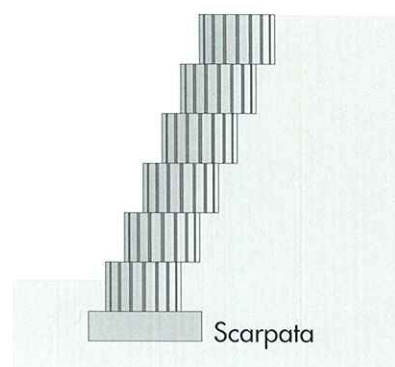

Scarpata

Posa

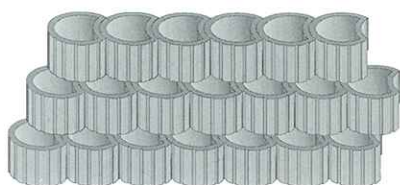

Fabbisogno: 18,5 pz./m²

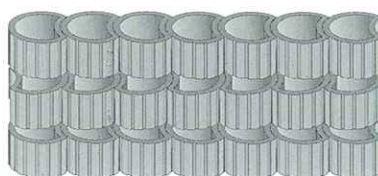

Fabbisogno: 18,5 pz./m²



Fabbisogno: 15,6 pz./m²

In vendita presso:

www.venir.ch

AGGLOMERATI DI CEMENTO SA

6512 Giubiasco
Tel 091/850 45 45
Fax 091/850 45 46

BAUSTOFFWERK AG SURAVA

7201 Untervaz - Bahnhof
Tel 081/322 39 51
Fax 081/322 64 54

BETON CHRISTEN AG BAUSTOFFE MUTTENZ

4020 Basel
Tel 061/378 79 80
Fax 061/378 79 00

SILIDUR AG ANDELFINGEN

8450 Andelfingen
Tel 052/317 10 21
Fax 052/317 14 06

SULSER AG TRÜBBACH

9477 Trübbach
Tel 081/750 20 40
Fax 081/750 20 45

VERBUNDSTEIN AG ZÜRICH

8196 Wil ZH
Tel 01/879 19 50
Fax 01/879 19 59