

RETINI - AGGLOMERATI DI CEMENTO

LINEO 20x10 - 20x20

Disegno 10

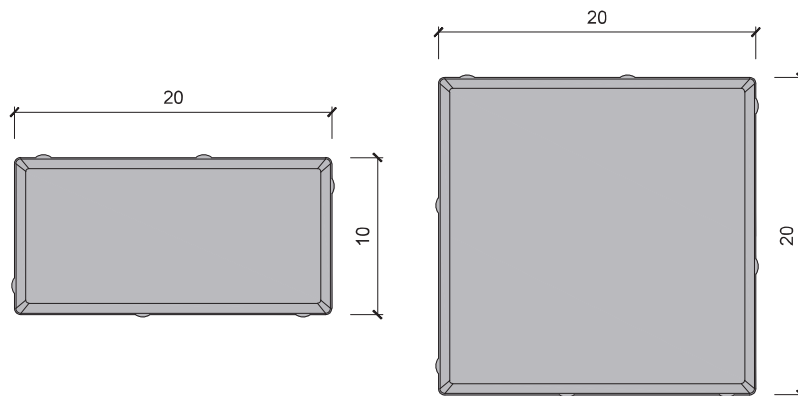
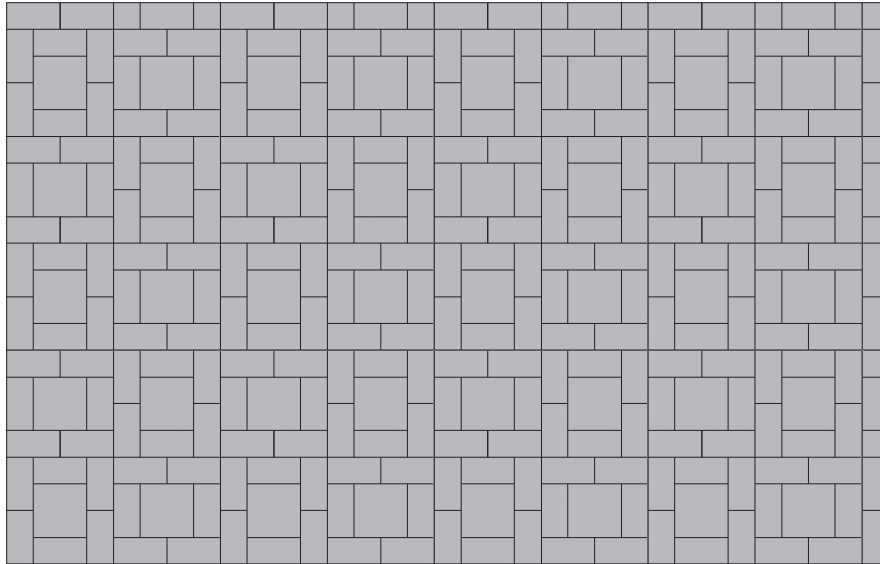

MODELLO RETINO DWG/DXF

