

# RETINI - AGGLOMERATI DI CEMENTO

## LINEO 20x20

Disegno 5

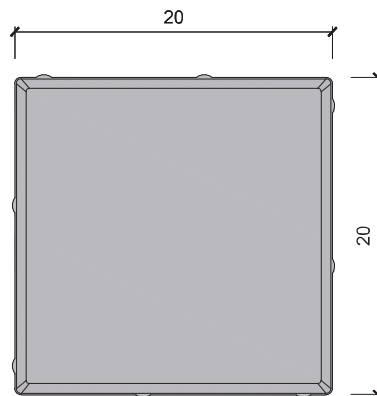
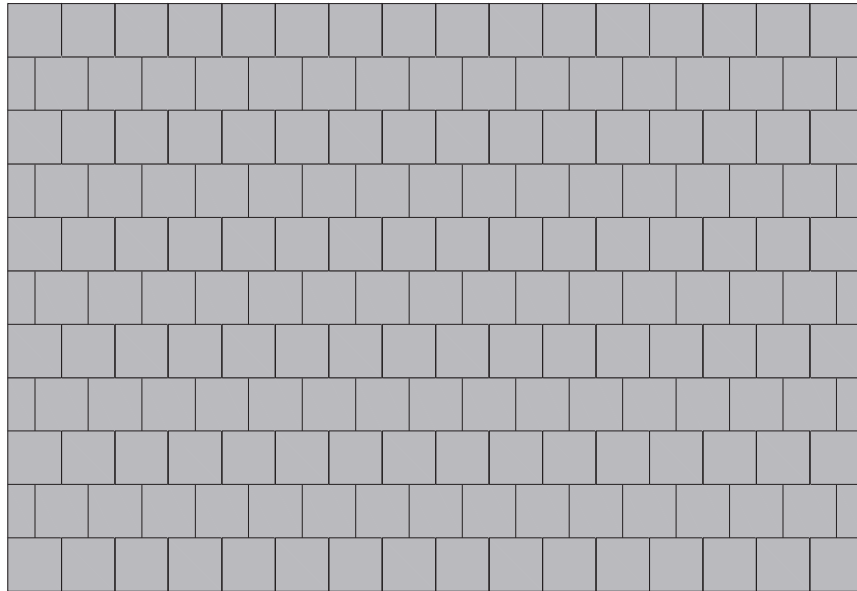

MODELLO RETINO DWG/DXF

