

RETINI - AGGLOMERATI DI CEMENTO

VIBLOC

Disegno 2

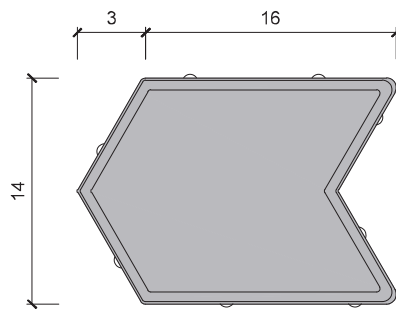
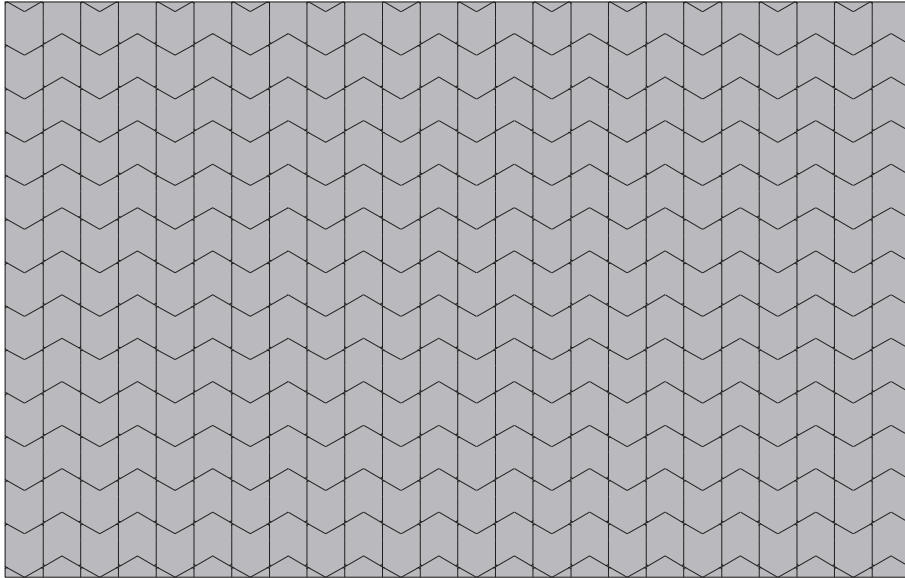

MODELLO RETINO DWG/DXF

