

# RETINI - AGGLOMERATI DI CEMENTO

## VIBLOC

Disegno 4

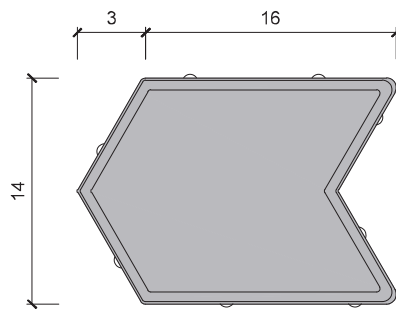
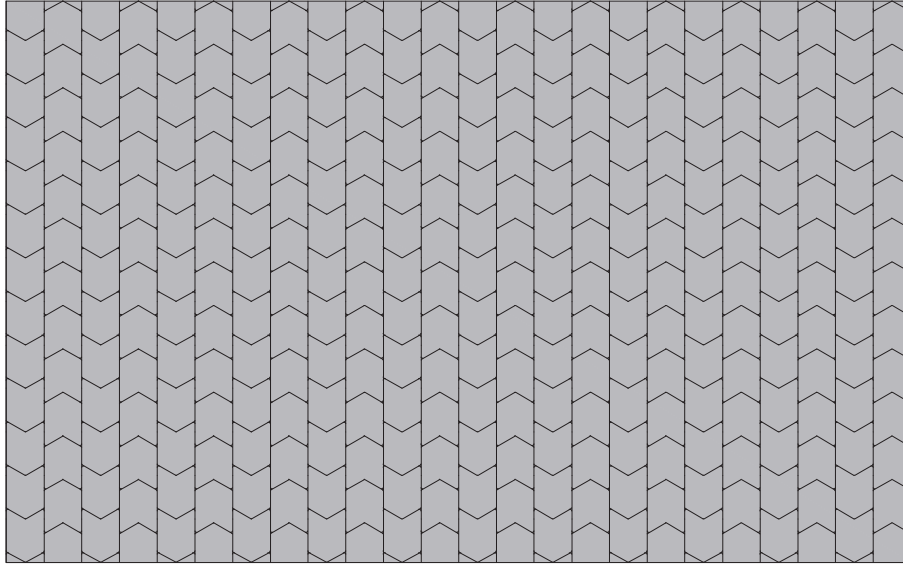

MODELLO RETINO DWG/DXF

