

RETINI - AGGLOMERATI DI CEMENTO

VIBLOC

Disegno 5

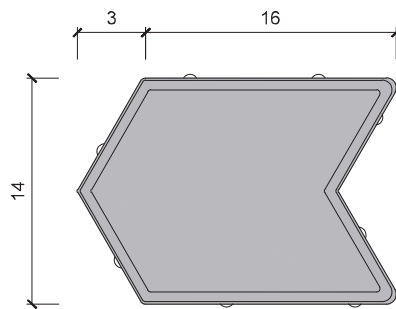
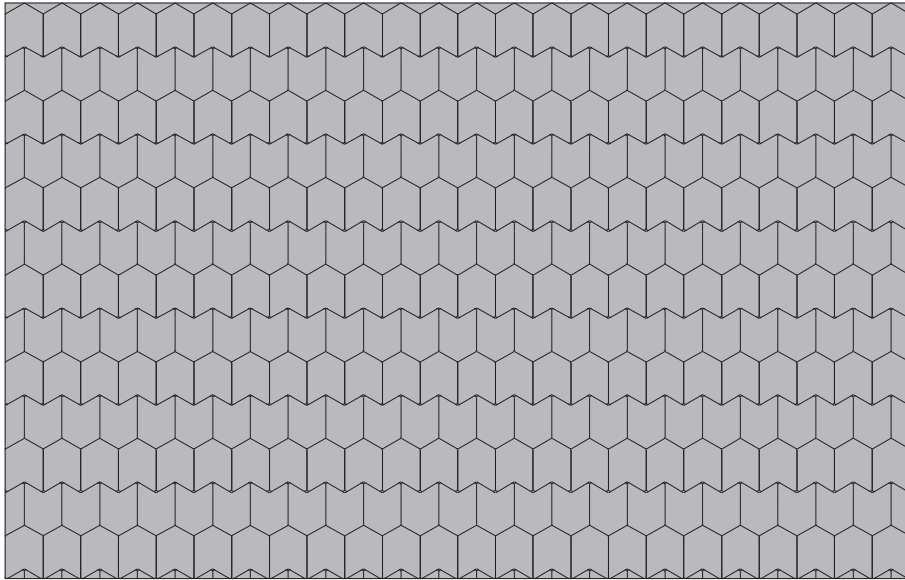

MODELLO RETINO DWG/DXF

