

RETINI - AGGLOMERATI DI CEMENTO

VIBLOC

Disegno 6

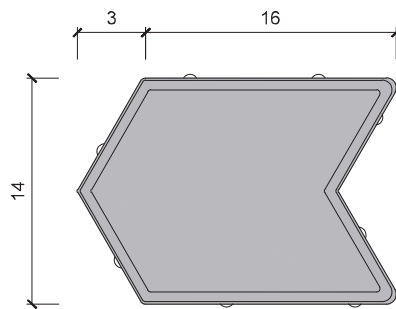
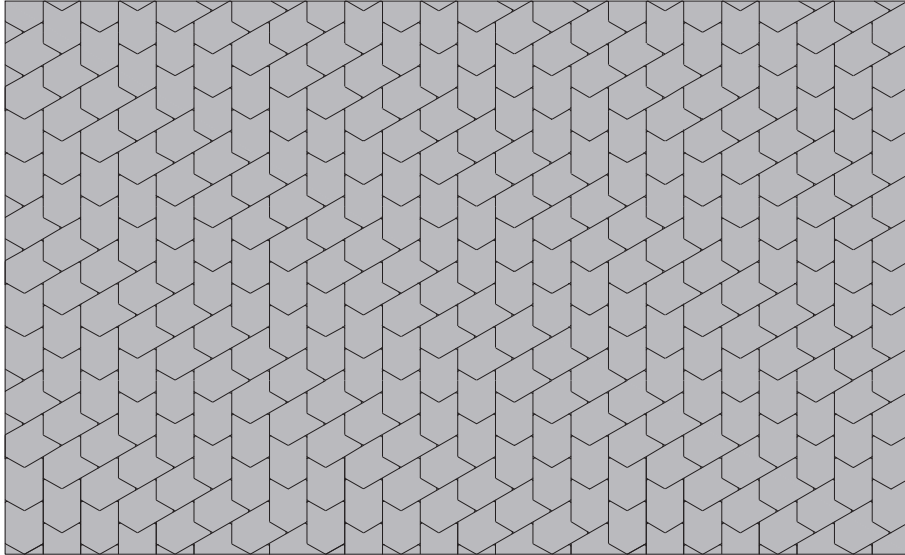

MODELLO RETINO DWG/DXF

