

RETINI - AGGLOMERATI DI CEMENTO

VIBLOC

Disegno 7

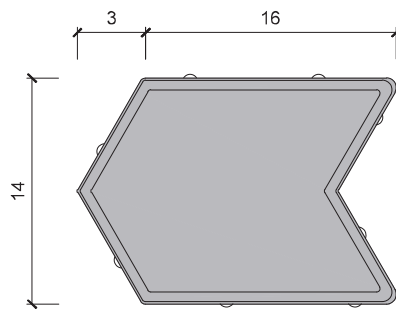
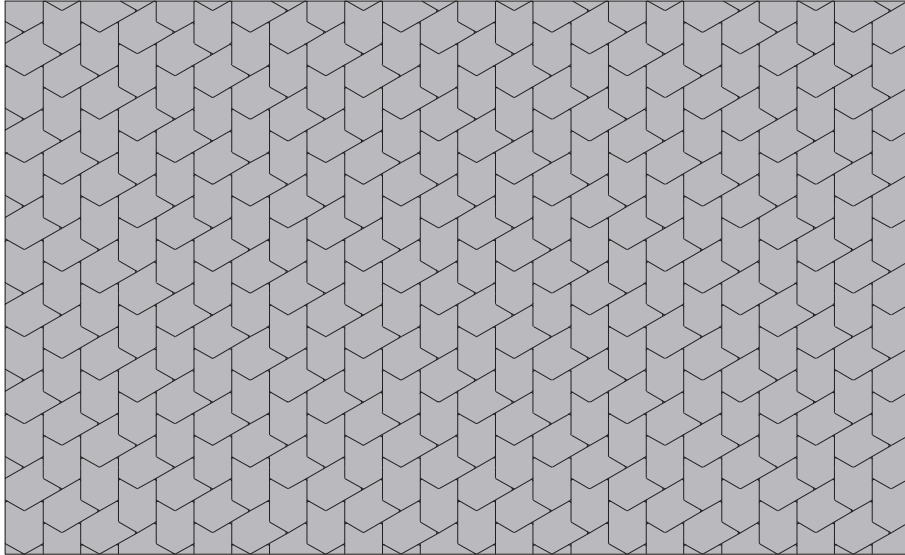

MODELLO RETINO DWG/DXF

